



1. Preface

QD81B is our latest universal control system for both DC & AC inverter cabinet air conditioners. Thank you for choosing this product, and it's our great pleasure to bring convenience for your daily life. Please read the user's manual carefully before using this control system, which will assist you to install and use the control system correctly.

2. Control system introduction

- 1) Parts of control system: ① universal indoor board, ② remote control, ③ universal outdoor inverter board, ④ electrolytic capacitor board.
- 2) To identify the working principle of the air conditioner (AC inverter or DC inverter) before installation.
- 3) No signal cable is needed. Connect the outdoor inverter board with COMP terminal of the indoor board according to the wiring diagram. The control system will work normally and adjust the running frequency intelligently.
- 4) With 3 minutes' delay for protection, the compressor will restart after 3 minutes once power off or defrost.
- 5) If the air conditioner works noisily, check three phases to see if there are cases of phase missing or phase dislocation. Ensure the maximum compressor working current is not over 110% rating current of the air conditioner.

3. Attentions before installation

- ▲ Maximum service power 24000BTU
- Please hire professional technicians for installation and do conduct power-on test before it. There is still high voltage in the board within 3 minutes after power off. Please be careful.
- Stabilize QUNDA's heat sink with the original one through silicone grease to ensure better heat dissipation.
- Users just need to use the gear 1 on the outdoor inverter board to select DC inverter or AC inverter. Ensure other gears remain default setting.
- Gear 1 (at the side of number ) on outdoor inverter board is suitable for DC compressor. So before installation, please distinguish the compressor model (DC inverter or AC inverter). For AC inverter, please set gear 1 to be on state.
- The electrolytic capacitor positive/negative pole must be connected to the ⊕ and ⊖ plug of the module correctly.
- Connect the three cables (U, V, W) of the original compressor with plugs (U, V, W) of the outdoor inverter board correspondingly. Ensure the connection is stable.
- Any damage due to improper installation or burned module resulting from human factors are not in warranty scope. If products need factory maintenance, please return the main board together with the packing box and a note to clarify specific failure phenomenon.

4. Outdoor board instruction

4.1 Structure and installation of outdoor inverter board

1) Outdoor inverter board structure diagram

- 1) Dial switch: it has 4 gears to choose. Users just need to use gear 1 to select DC inverter or AC inverter. Ensure other gears remain the default setting. The default setting (Number end) for gear 1 on outdoor inverter board is suitable for DC compressor. So before installation, please identify the compressor model (DC inverter or AC inverter). For AC inverter, please set gear 1 to be on state.
- 2) Exhaust temperature sensor connection socket: once compressor exhaust temperature is higher than 110°C, it will be shut down for protection.
- 3) Indicator light: when the unit is working normally, choosing DC inverter, the green LED light will be on; Choosing AC inverter, the green LED light will flicker. When failures occur, the green LED light will be off, and the red LED light will flicker. The red LED light will flicker with diverse frequency according to the failure phenomenon. For details, please check the error indication for reference.
- 4) COMP TERMINAL: connect with the COMP of the universal indoor board.
- 5) N TERMINAL: Null line input.

- 6) ⊕ TERMINAL: connect with the positive pole of electrolytic capacitor board.
- 7) ⊖ TERMINAL: connect with the negative pole of electrolytic capacitor board.
- 8) U, V, W output terminal: Connect with the cables (U, V, W) of compressor correspondingly. If it rotates reversely, please exchange two cables of them.
- 9) Fixed pole for radiator: Stabilize the outdoor inverter board on the heat dissipation sink of the original unit.

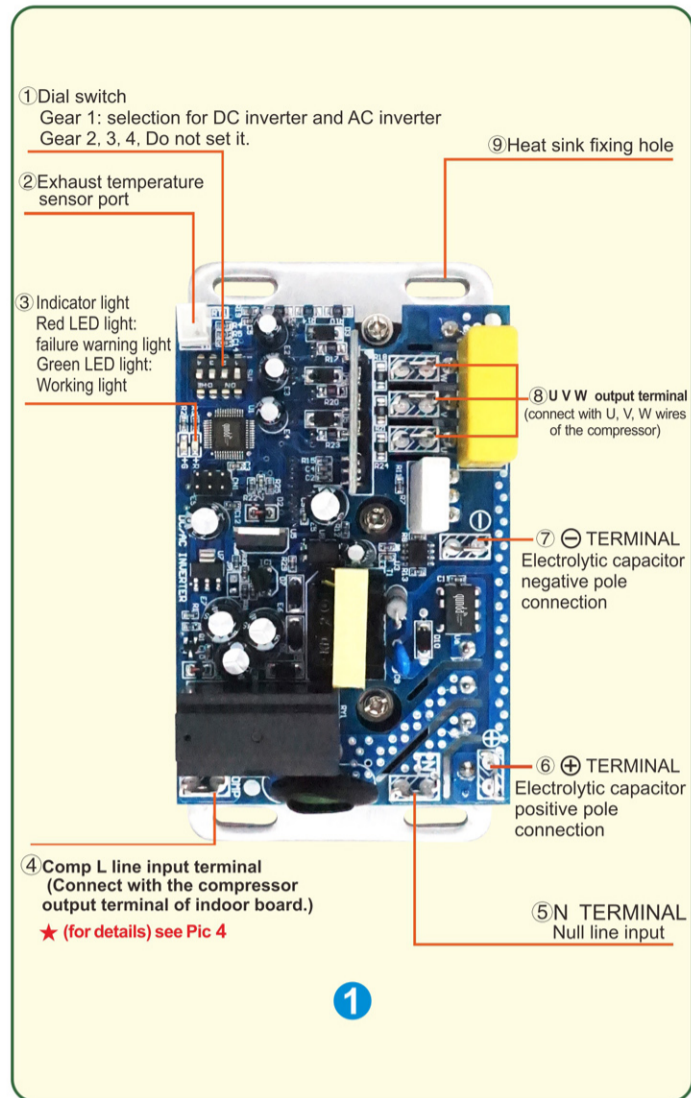

GEAR	ON	NUMBER END
1	AC inverte	DC inverter
2	NULL	NULL
3	NULL	NULL
4	NULL	NULL

2) Installation for outdoor inverter board:  
Test before installation:  
Step 1: Power the control system to make sure it is in good condition.

After power on, if the green LED light is on, which means DC inverter selected. If the green LED light flickers, which means AC inverter selected. Step 2: Before installation, please use the ohm band of the multimeter to test the compressor and make sure the compressor coil is good and the resistance of three compressor feet is the same. If not, something may be wrong with the compressor. In that case, don't install the control system to avoid damaging it.

▲ Stabilize QUNDA's original heat sink with the original one through silicone grease to ensure better heat dissipation. And also use two screws to tighten up the two heat sinks.

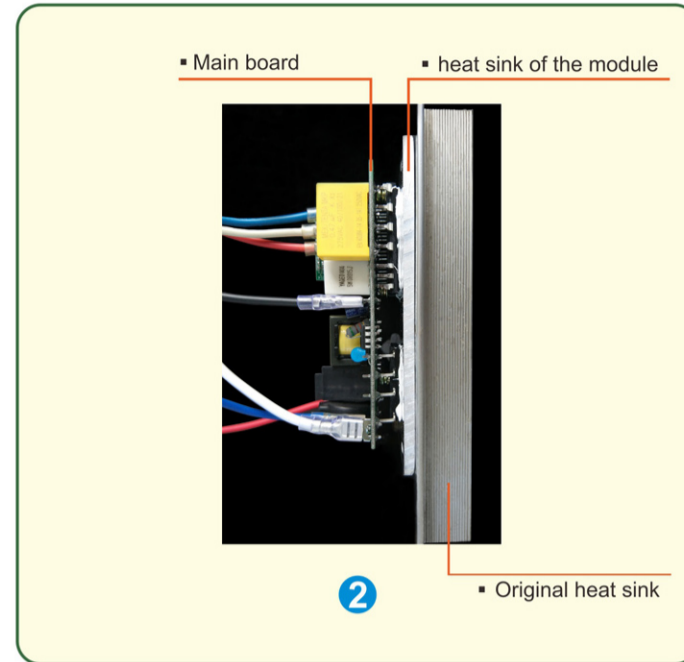

3) Install the final diagram for reference

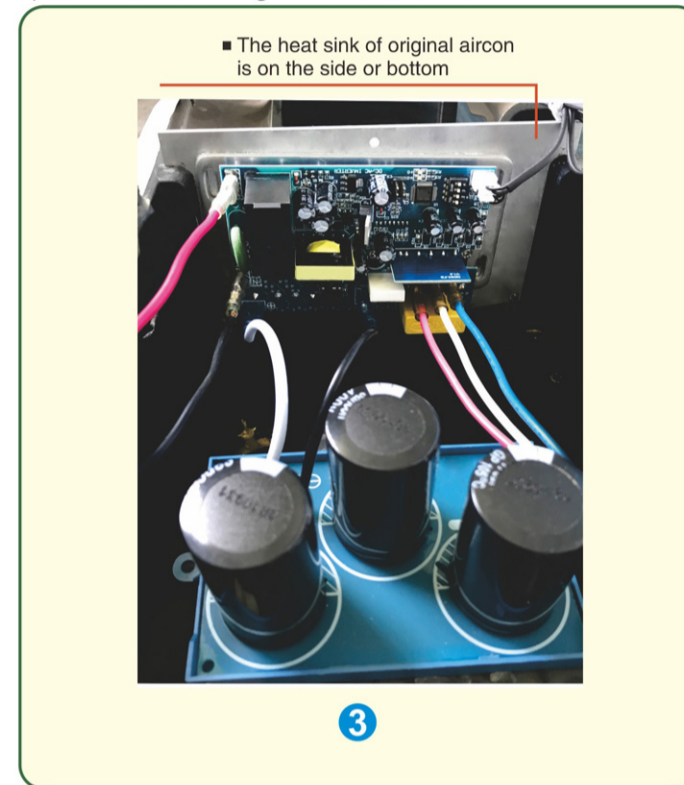

4.2 Failure Guide for Outdoor Units

● AC inverter board error indication:

Red LED light flashing frequency	Error explanation
Once	DC bus over voltage or under voltage
Twice	Over current protection
3 times	IPM over current protection
4 times	Over exhaust temperature

● DC inverter board error indication:

Red LED light flashing frequency	Error explanation
Once	DC bus over voltage or under voltage
Twice	Over current protection
3 times	IPM over current protection
4 times	Over exhaust temperature
5times	Compressor rotor out-of-step trouble

● Note: when the stop alarm sounds, shut down and restart it to clear the alarm.

4.3 Technical parameters

Application scope	Cabinet air conditioner
Service power	13000-24000BTU
Maximum input voltage	AC240V
Minimum input voltage	AC180V
Maximum output current	20A
Maximum output frequency	100Hz

4.4 TIPS

- How can you verify the unit is AC or DC inverter?  
1. Check the mark on the side of the unit.  
2. If you still have no idea about it, please call us.



5. Indoor board instruction

5.1 Indoor board wiring diagram and installation instruction

1) Universal indoor board controls the compressor driven board, four-way valve and outdoor fan.

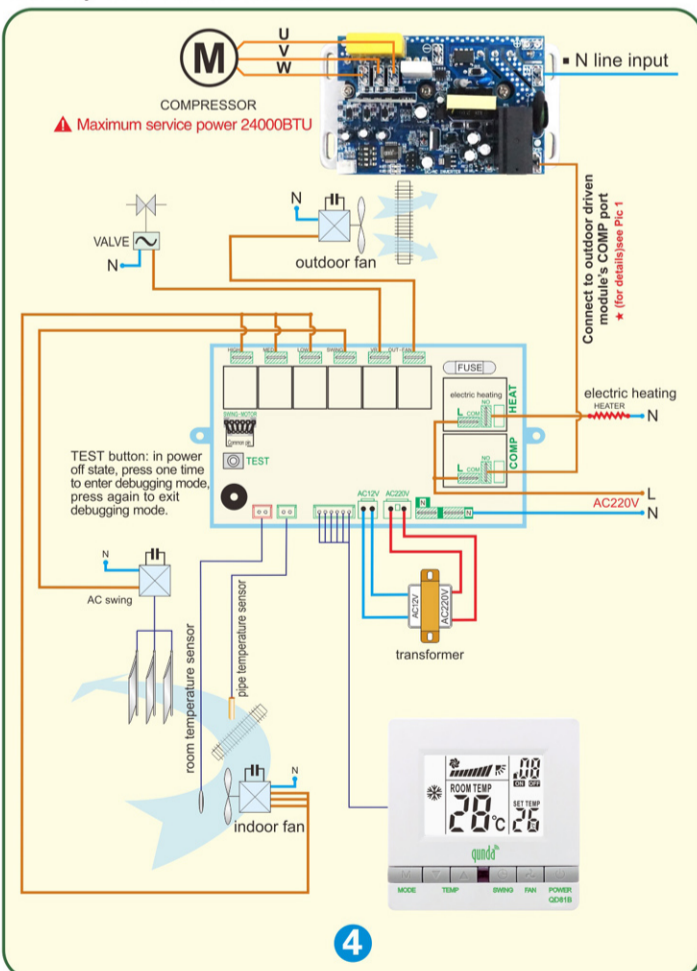

- Attention:**
- The output socket of step motor is 6 pins, and common ports (12V) are on the both sides. The common port of swing motor plug must be inserted into one common port of step motor output socket. If the motor rotates reversely, reinsert the plug into the other one.
  - No hard light in front of IR receiver.

5.2 Indoor board error indication

Error display (in display panel)	Error explanation
Room temperature area displays $\text{fl}$ or $\text{Er}$	Room temperature sensor fault
On debugging mode, Setting TEMP area displays $\text{fl}$ or $\text{Er}$	Pipe temperature sensor fault

5.3 Display panel instruction

- 1) Power button. Turn on or off the controller manually.
- 2) Fan speed select. When power on, used to toggle the fan speed among high, middle, low and auto.
- 3) Wind direction. When power on, used to control the swing moving or stopping.
- 4) Up button. When power on, used to rise the temperature.
- 5) Down button. When power on, used to decrease the temperature.
- 6) Mode button. When power on, used to toggle the controller mode among cooling, heating, ventilating, drying, auto.
- 7) IR receiving window. Used to receiving order from remote controller.

- 8) Ventilate symbol. Indicate the working mode is ventilating.
- 9) Heat symbol. Indicate the working mode is heating.
- 10) Cool symbol. Indicate the working mode is cooling.
- 11) Dry symbol. Indicate the working mode is drying.
- 12) Auto symbol. Indicate the working mode is auto.
- 13) Fan working symbol. Symbol rotating indicates the fan is working, stilling indicates the fan stops.
- 14) Auto fan speed symbol. The symbol going on indicates the fan on auto mode.
- 15) Manual fan speed symbol. 3-line indicates low fan speed, 6-line indicate middle fan speed, 9-line indicates high fan speed.
- 16) Swing symbol. The symbol going on indicates swing waving.
- 17) Sleep symbol. The symbol going on indicates sleep mode on.
- 18) Compressor symbol. The symbol going on indicates compressor is on.
- 19) Timing time. On the state of timer on or off, it displays the hour.
- 20) Timer off symbol. The symbol goes on once timer off set.
- 21) Timer on symbol. The symbol goes on once timer on set.
- 22) Setting temperature. It indicates the setting temperature or "dF" means it is defrosting.
- 23) Room temperature. ROOM TEMP area displaying the room temperature.

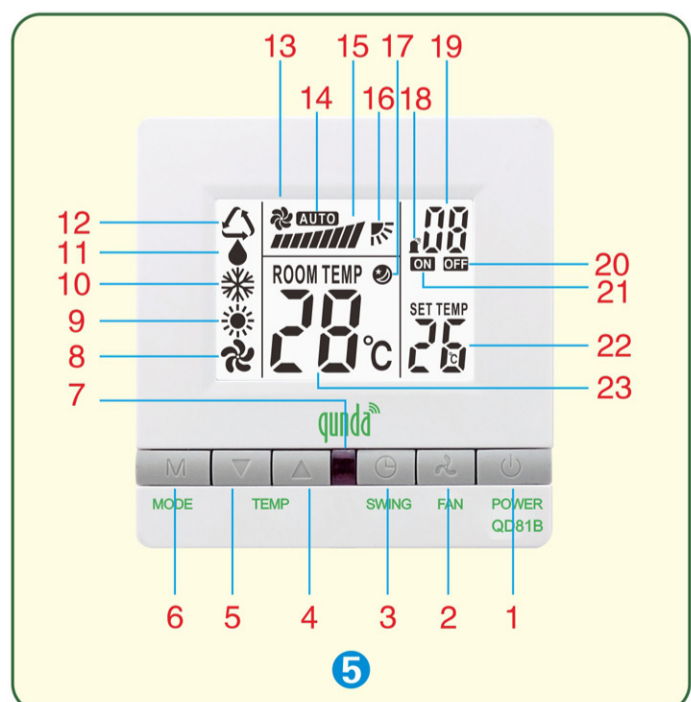

5.4 Auto restart function selecting

Auto restart function is optional for your own chosen. Setting method as the following:

- 1) On the off state, press and hold the mode button for 5 seconds.
- 2) At this moment "P1" symbol is displayed in the room temperature area, and "01" is displayed in the setting temperature area (the default setting is 01 which means memory function enabled).
- 3) No need to enable the memory function, please press  $\blacktriangledown$  button to adjust the display to "00". If the memory function needed, please press  $\blacktriangle$  button to adjust it back to "01".
- 4) After finalizing all the setting, please press power button to save it. And it will be back to power off state. If no any adjusting within 15 seconds, our system will save the it automatically and be back the power off state.

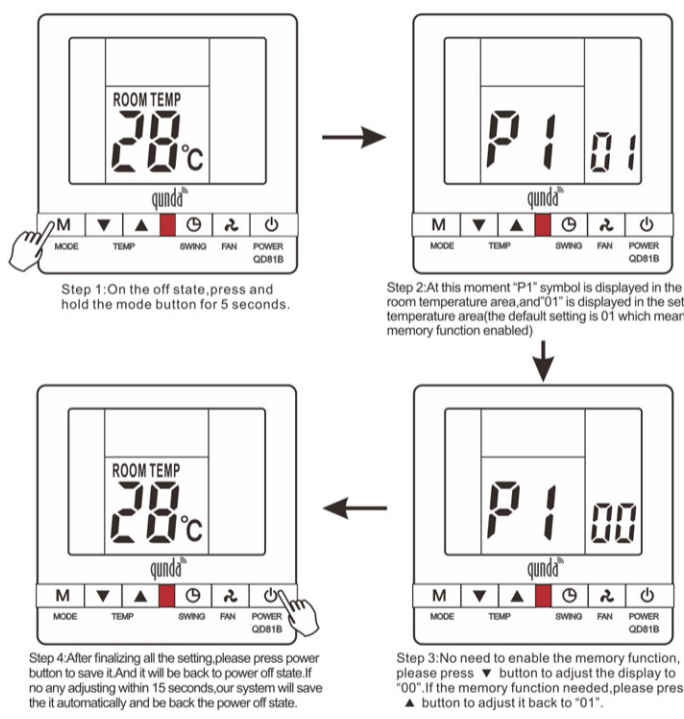

5.4 Indoor unit remote manual

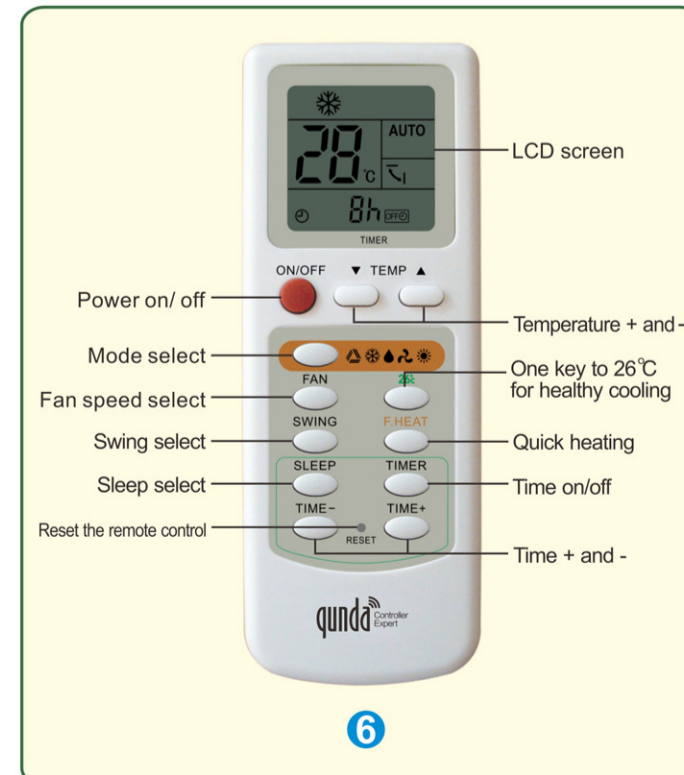

- 1) ON/OFF key: press to turn on/off the A/C.
- 2) TEMP (temperature setting key): it can set the temperature from 16°C to 30°C. The key would not work under the auto or dry mode.
- 3) Mode key: working modes conversion (auto, cooling, dry, ventilation, heating). In the auto mode, the A/C would come to the heating mode when the room temperature is under 21°C; when the room temperature is higher than 27°C, the A/C would come to the cooling mode. The

- setting temperature is 24°C.
- 4) Fan key: fan speeds conversion. In the dry mode, the Indoor fan is low speed and works automatically: it is the high speed when the temperature gap between the setting temperature and the room temperature is more than 4°C; 2-3°C is the middle speed; 2°C is the low speed. The wind speed would convert in every minute.
  - 5) 26°C key: 26°C key would set the A/C in the cooling mode and provide you the environmental-friendly and comfortable temperature.
  - 6) SWING key: press to set the vane to swing or not.
  - 7) F. HEAT key: 20°C key would set the A/C in the heating mode and provide you the environmental-friendly and comfortable temperature.
  - 8) SLEEP: press to set the sleep mode. In the sleep mode, the fan coil would turn off automatically in 8 hours.
  - 9) TIMER: press for timer on/off or cancelling the timer.
  - 10) TIME+ / TIME-: the time setting range from 1 to 16 hours.
  - 11) RESET: press to reset the remote control.

6. Packing components

Item	Number	Unit
universal indoor board	1	piece
indoor unit sensor	2	piece
indoor unit transformer	1	piece
indoor unit display panel	1	piece
outdoor inverter board	1	piece
Compressor exhaust temperature sensor	1	piece
Electrolytic capacitor board	1	piece
remote	1	piece
User's manual	1	piece
Material pack	2	bag

Company information

Name: QUNDA Control Technology (Jiangsu) Co., Ltd.  
Address: No.888 LongQiao Road, WuJiang District, SuZhou, China  
Post code: 215200 Web site: www.qunda.com

★ Revised the right of final explanation. Any alteration on the design and model will not be further notified.