



1. Preface

Dear client,
 Thank you for choosing Qunda QD-HVAC thermostat series. It's our best wish that can bring convenience to your daily life. Before using the Controller, please read the User's Manual carefully, it will help you to use it correctly.

2. Production Function Overview

- 2.1 Application**
 QD-HVAC08E can control a two-way electric valve and a three-way electric valve, or two two-way electric valves on Heating and Cooling.
 QD-HVAC08E is applicable to two-pipe HVAC, and four pipe water system or air system HVAC. It controls the working condition of FCU (Fan Coil Unit) and electric valve by comparing the ambient temperature and setting temperature, to adjust the temperature for a comfortable environment and save energy.
 QD-HVAC08E is based on industrial-grade micro-computer technology with touching key operation and LCD display. The controller is simple-operating, stable and reliable.
- 2.2 Feature**
- ▶ Elegant and fashion appearance, suitable for Shopping Mall, Hotel, Office and Home
 - ▶ Operating voltage is AC85-260V.
 - ▶ Big LCD display and touching key operation
 - ▶ Using graphic symbol for working mode and condition, Heating, Cooling, Ventilation and fan speed, etc.
 - ▶ Showing ambient temperature and setting temperature separately
 - ▶ Press key to choose working mode of Heating, Cooling and Ventilation, etc.
 - ▶ Press key to choose fan speed on Automatic or manually
 - ▶ Fan and valve are controlled by switch
 - ▶ With Sleep and Timing function
 - ▶ Keeping the condition and setting permanently
 - ▶ Can choose low temperature protect mode if necessary after shut down
 - ▶ Temperature correction function
 - ▶ Fan operating condition setting
 - ▶ Valve opening delay function
 - ▶ Key lock function
 - ▶ Automatic re-start after power failure
 - ▶ Backlight Function
 - ▶ Buzzer sound alarming
 - ▶ Control two-way, three-way valve and two two-way valves on Heating and Cooling
 - ▶ IR hand control (Purchase separately)

3. Front and Back Diagram and Description

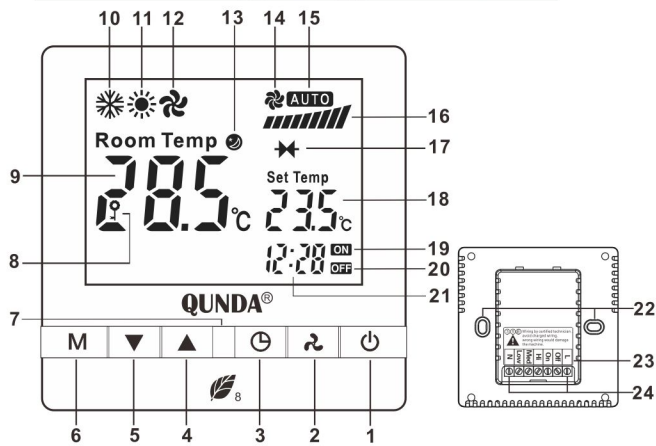

Description

Item	Description
1	Power on/off, used to turn on and off the thermostat
2	Fan speed. Used to change the fan speed of high, middle, low and auto when power on.
3	Timer. Used to set timer off and sleep when power on and timer on when power off.
4	Up. Used to up the temperature when power on; adjust parameter when in Factory setting.
5	Down. Used to down the temperature when power on; adjust parameter when in Factory setting.
6	Mode. Used to select mode on Cooling, Heating and Ventilation when power on. Switch different types of parameter when in factory setting mode.
7	IR receiving window. Used to receiving order from controller.
8	Key lock symbol. If it shows on screen, the keys are only on/off button works. If do not show on screen, the keys are unlocked.
9	Room temperature. Show the room temperature when power on.
10	Cooling symbol. Indicate current working mode is cooling when power on.
11	Heating symbol. Indicate current working mode is Heating when power on. It is low temperature protection symbol when power off.
12	Ventilation symbol. Indicate current working mode is ventilation.
13	Sleep symbol. It shows on the screen when turn on Sleep Function,
14	Fan running symbol. If the symbol running means the fan works, if not, the fan doesn't work.
15	Auto fan speed.
16	Manually fan speed. 3 bars means low, 6 bars means middle and 9 means high.
17	Valve condition symbol. It will show on the screen when the Valve is on.
18	Setting temperature. Show the setting temperature when power on.
19	Timer on symbol. Show on the screen when use timer on function.
20	Regular shutdown symbol. Show on the screen when use timer off function.
21	Timing. Show the detail time when using timing function.
22	Tapping hole in the bottom. Used to fasten the bottom with the holder.
23	Wire symbol. It will be different on different model or different specification.
24	Terminal block. Used to connect to outside wires. The number of terminal will be different on different model or different specification.

4. Basic operation

1. Power on/off. Press "⏻" to turn on, figure symbol displays on screen; press "⏻" again to turn off, figure symbol disappears and shutdown FCU, electric valve, ball valve or air valve.
2. Temperature setting. Press "▲" and "▼" to set temperature when power on. Press the key first time, it shows current temperature setting and flicker, Press "▲" and "▼" again to make the temperature up/down. It will be 1 by pressing one time.
3. Mode selection. Press "M" to shift work mode. Press one time, it shows current mode and flicker. Press "M" again to shift the mode, "❄️" means Cooling, "🔥" means Heating and "🌀" means Ventilation.
4. Fan Speed selection. Press "🌀" to select fan speed of High, Middle, Low and Auto when power on. Press one time, it shows current fan speed and flicker, press "🌀" repeat to select relevant speed.
 Remark: If it's in Auto speed, it will shift base on difference range between indoor temperature and setting temperature. When it is over 3 difference., it will shift to High;

- when it is 2-3 , it will be Middle; when the difference is below 1 , it will be Low then. When indoor temperature reaches setting temperature, fan stops or Keeps working based on Factory setting.
5. Timer button. Press "⌚", it shows sleep symbol and flicker when power on. Press "⌚" again , it will shut down in 1 hour, press "⌚" repeat, to change timing period. When It's over 16 hours, timer function cancels. If sleep symbol or timer symbol do not flicker, press "⌚" to cancel those two settings; Press "⌚" one time when power off, it will turn on in 1 hour, press "⌚" repeat to changing timing period. When It's over 16 hours, timer function cancels. If Timer symbol do not flicker, press "⌚" to cancel the setting.
 Remark: When using the function of temperature setting, Fan speed selection, Mode selection and Timer, the relevant symbol flicker means the function setting is active. If no operation in 5 seconds, the setting is confirmed. Within the 5 seconds, the thermostat will stay on previous setting.
6. Lock function. Press "🔒" and "🔒" for 5 seconds at the same time, it shows "🔒" on screen, all keys are locked. And do it again, "🔒" disappear, all keys are unlocked. In Locked condition, only on/off button works.
7. Backlight function. Backlight off when controller is off and on when it is on and operating. Backlight off automatically without any operation in 5 seconds.
8. Buzzer sound alarming for ON and OFF.
9. Hand control (purchase separately).

5. Control to Electric Valve and Fan

- 5.1 Controls to Electric Valve**
- 5.1.1 Two-pipe water system (F1=1, F2=2)
 In Cooling (Heating) mode, when the indoor temperature is 1 higher (lower) than setting temperature, open electric valve, and close electric valve when it reaches setting temperature.
- 5.1.2 Four-pipe water system (F3=3)
 In cooling mode, when indoor temperature is 1 higher than setting temperature, open cold water valve and close cold water valve when it reaches setting temperature. In heating mode, when indoor temperature is 1 lower than setting temperature, open hot water valve and close hot water valve when it reaches setting temperature. The cold water valve is always shut down in heating mode.
- F1=1 (Two-way valve) F1=2 (Three-way valve) F1=3 (HEAT/COOL valve)
- 5.2 Fan control**, High middle, low three outputs for fan speed, and two work modes. Select the Fan mode by setting factory parameter F3.
- A) F3=1 Fan mode 1, temperature reaches setting temperature, fan stops.
 B) F3=2 Fan mode 2, temperature reaches setting temperature, fan works.

6. Factory Parameter set up

- Users can adjust Factory parameter set up to satisfy different application.
- 6.1 Factory setting mode**
- 6.1.1 When power off, press "M" and "🌀" for 5 seconds at the same time, "F1" appears in LCD and related parameter in temperature setting area. Release the key and into Factory setting mode.
 - 6.1.2 Press "M" to shift from F1-F7, press "▲" and "▼" adjust relevant parameter.
 - 6.1.3 Press "⏻" to save and exit from Factory parameter set up. Exit automatically without any operation in 30 seconds and return to previous setting.
- 6.2 Factory Parameter**

Code	Function	Range	Description	Factory Setting
F1	Valve type	1-3	1: two-way valve 2: three-way valve 3: heat/cold valve	2
F2	Temperature correction	-9~+9	Adjust temperature deviation	0
F3	Fan mode	1-2	1: temperature reaches setting temperature, fan stops. 2: temperature reaches setting temperature, fan works.	1



F4	Low temperature protection	1-2	1. off 2. on	1
F5	Auto restart	1-2	1. off 2. on	1
F6	Valve opening delay	1-2	1. off 2. on	1
F7	Key lock	1-2	1. off 2. on	1

- 6.3 Factory parameter description**
- 6.3.1 F1: Valve type setting, please refer to Cause 5.1
- 6.3.2 F2: Temperature correction. There will be deviation because of the controller's location, users can adjust the temperature by correction function on the range of -9~+9
- 6.3.3 F3: Fan mode setting. Please refer to Cause 5.2.
- 6.3.4 F4: Low temperature protection. It is used to avoid frozen the water pipe. When the function works meanwhile the controller is off, thermostat would be in heating mode and shows "❄️" symbol when indoor temperature lower than 5 . Fan works automatically with high speed and open electric valve (or hot water valve). Thermostat will be off automatically when indoor temperature reaches 7 .
- 6.3.5 F5: Auto restart function. It is used to reverse the setting before power off and restores the previous setting after power on.
- 6.3.6 F6: Valve opening delay. It is used to 3 mins delay for the valve opening after it shut down.
- 6.3.7 F7: Key Lock. If keys are locked, only on/off key works.
- 6.4 Restore to factory settings.**
 When power off, press "M" and "⏻" for 5 seconds at the same time, "dEFr" appears in LCD. Release the key and press "⏻", then restore to factory setting.

7. Installation

- 7.1 Preparation**
- 7.1.1 Please read the clause 10. Important reminding and notice.
 - 7.1.2 Make following preparation
 - 7.1.2.1 Install location confirmed. Pre mounted 86*86 wire box by the fasten bolt in controller package.
 - 7.1.2.2 Prepare the wiring diagram according to the equipment like valve and thermostat model.
 - 7.1.2.3 Install wire and labeled every single wire for next step.
 - 7.1.2.4 Shut down AC220V power supply switch, check wire connection of Fan and Valve and the label of pre-loaded wires are clear.
- 7.2 Install steps**
- 7.2.1 Please make the installation follow the diagram and instruction after preparation completed.
 - 7.2.2 Notice
 Please take the LCD protection film before using after all installation.

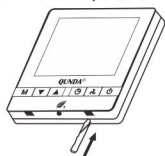

Step 1: Insert the 3.5mm width screwdriver into slot 4mm.



Step 2: Pry it a little bit to disassemble the thermostat.

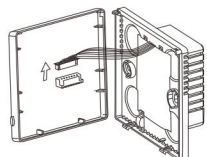

Step 3: Take off the flat cable in control board.

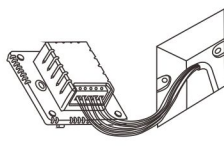

Step 4: Connect wire according to wiring diagram.

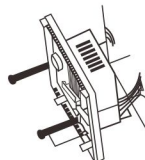

Step 5: Mounted the bottom on the wall by the bolt in controller Package.

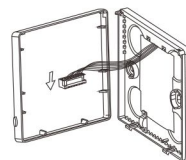

Step 6: Install Flat cable in Control board.



Step 7: Hang above two hooks in angle of 30 degrees, must put in place.

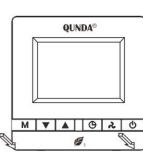

Step 8: Press the panel to fix in the bottom. Installation completed!

8. Wiring diagram

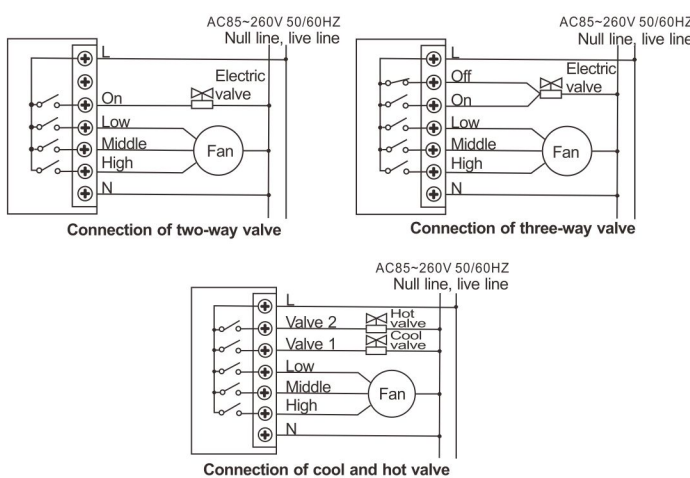

9. Trouble shooting

Declaration: All our product maintenance only can be done by technical personnel.

Trouble	Solution
Cannot turn on	1. Check if power for L N is correct and if the wire works. 2. Check if the ON/OFF button is work. 3. First replace main control board, if doesn't work, change power supply board.
Garbled in LCD	1. Back cover distortion when install, loosen fasten bolt.
No regular output	1. Damage of flat cable connected main control board and power supply board. 2. First replace main control board, if doesn't work, change power supply board.
Controller doesn't work	1. Check the battery of controller. 2. Change controller.
E 1 in LCD	1. Sensor problem, change front panel.

10. Important reminding and Notice

- 10.1 location to install thermostat**
 The right installation location is as shown in the right diagram, height usually 1.5 meter from ground. It should avoid following conditions.
1. Corner, near door or window, on the front or back of the door.
 2. Out of temperature control space, closed heating pipe or flue.
 3. Near air pipe or radiator
 4. Direct sunlight place or near other heating item. (TV)
- 10.2 Notice to installation of the temperature controller**
1. If using hard plastic wire for installation, please make the proper angle.
 2. Please connected all components strictly follow the Wiring diagram.
 3. One controller can drive one FCU and 1 two-pipe electric valve or 2 four-pipe electric valves.
 4. One controller can drive one air vent or air valve.
 5. Cannot drive magnetic element like electromagnetic valve.
 6. When assemble and disassemble flat cable, use thumbs to push the connector out, do not pull it.
 7. Please do not press on LCD and do not hit controller.
 8. LCD temperature controller is precise electric equipment, cannot fall during installation.
 9. Please do not let water, mud and other litter into temperature controller.
 10. Please take the LCD protection film before using.

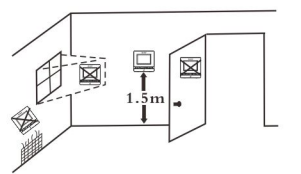

11. Technical Specifications

Temperature sensing element	NTC
Temperature control precision	±1
Temperature Setting	5-35
Display range	0-50
Working Condition	0-45
Humidity	5-95%RH
Key	Touching Key
Supply voltage	AC85-260V,50/60HZ
Consumable Power	<1W
Terminal block	2 lines X 1.5 mm2, or 1 line x 2.5mm2
Load limitation	2A with resistant load; 1A with inductive load
Shell	Fire-proof PC+ABS
Dimension	86x86x14 mm
Installation	60mm standard
Protection	IP30
Operation life	More than 100000 times